

Metal centered molecules and their application in chemistry and physics*

Michael Veith,† Andreas Rammo, Stefan Faber and Bernhard Schillo

*Institut für Anorganische Chemie, Universität des Saarlandes,
D-66041 Saarbrücken, Germany*

Abstract: Monocyclic as well as polycyclic silylamides of a series of main group metals such as Li, Ge, Sn and Pb (the last three elements mostly in the oxidation state +II) have been synthesized, analyzed by spectroscopic means and structurally characterized over the last 20 years. All these molecular compounds have in common a Lewis acidic (electrophilic) metal center with at least one bond to nitrogen. In the case of the bis(amino)germylenes, -stannylenes and -plumbylenes, the metal centers are poorly coordinated (only two bonds to nitrogen) and may directly react with organic π -systems. This nonclassical behaviour will be discussed shortly. If the metal atoms are more highly coordinated by intramolecular nitrogen or oxygen bases, the oxidation to stable germimines or germathiones is possible, whereas the corresponding tin compounds are only transient in nature. Finally, the use of special metal alkoxides [for example $\text{Ge}(\text{OtBu})_2$ or $\text{Sn}(\text{OtBu})_2$] or alkoxohydrides like $[\text{H}_2\text{AlOtBu}]$ as single source precursors in the chemical vapour deposition process to form biphasic nanocomposites of metal clusters in a metal oxide matrix is highlighted. The composites obtained from this technique have peculiar fractal structures.

INTRODUCTION

Main group metal centered molecules with organonitrogen or oxygen ligands have been known since the last century, their importance as reagents in molecular reactions being noticed especially by Bradley, Mehrotra [1–3] and Lappert [4,5]. Since these early reviews, most new compilations have appeared with emphasis on the special uses of these two classes of compounds [6–10]. In 1987, we reviewed, for the first time, the syntheses, characterizations and general uses of cyclic compounds of the general formula $\text{Me}_2\text{Si}(\text{NR})(\text{XR})\text{MY}$ [$\text{M} = \text{Li}, \text{Na}, \text{Mg}, \text{Al}, \text{Ga}, \text{In}, \text{Tl}(\text{i}), \text{Tl}(\text{iii}), \text{Ge}(\text{ii}), \text{Sn}(\text{ii}), \text{Pb}(\text{ii}), \text{P}(\text{iii})^+, \text{As}(\text{iii})^+, \text{Sb}(\text{iii})^+, \text{Bi}(\text{iii})^+$; $\text{X} = \text{N}, \text{O}$; $\text{Y} = \text{organic ligand or electron lone pair}$] [11]. The scope of the following article is to present the latest progress in the direct interaction of some of these cyclic compounds with organic π -systems like cyclopentadiene, cyclohexadiene, $\text{Ph}_3\text{P}=\text{CH}_2$, etc. In the second chapter, the oxidation of intramolecularly base stabilized bis(amino)-germylenes and -stannylenes with phenyl azide, trimethylsilyl azide or elemental sulfur is discussed. So far, only the germimine and the germathione have been isolated; the corresponding tin compounds have been only observed as transient species. In the third chapter, the **single source precursor approach** in chemical vapour deposition (CVD) techniques to form biphasic metal/metal oxide composites is discussed. This elegant process uses metal alkoxides as precursors taking advantage of unique bonding features which become evident when the temperature is raised.

*Lecture presented at the 5th International Conference on Heteroatom Chemistry (ICHAC-5), London, Ontario, 5–10 July 1998, pp. 369–512.

†Corresponding author: E-mail: veith@rz.uni-sb.de

DIRECT INTERACTIONS OF BIS(AMINO)GERMYLENES, -STANNYLENES AND -PLUMBYLENES WITH ORGANIC π -SYSTEMS

Cyclic bis(amino)germylene (**1**), -stannylene (**2**) and plumbylene (**3**) are readily available from the dilithium salt $\text{Me}_2\text{Si}(\text{tBuN})_2\text{Li}_2$ by reaction with GeCl_2 -dioxane, SnCl_2 or PbCl_2 in diethyl ether (eqn 1) [12,13].



1 (M = Ge), **2** (M = Sn), **3** (M = Pb)

An X-ray structure determination on single crystals of **2** reveals the molecule to be partly monomeric (there is a 1:1 mixture of monomers and dimers in the crystal structure) in the solid phase [14]. In solution all three compounds **1**, **2** and **3** are strictly monomeric and consist of one electrophilic center (metal atom) bonded to two nucleophilic nitrogen atoms. The whole bonding system can thus be conceptually considered with multiple bonds as may be seen from mesomeric formulae **A**, **B** and **C** (Scheme 1, see also [11]).

Consequently, these molecules should react with organic π -systems in three different ways: (a) $p\pi-p\pi$ bonds with high electron density should form complexes through metal- π -electron interaction similar to a Lewis-acid-base complex; (b) C=C double bonds with acidic hydrogen atoms adjacent to the π -bond should add over the formal N-M double bond; and (c) acyclic dienes should oxidize the metallic element to form a metallacyclopentene. All three reaction pathways are observed where the nature of the metallic element Ge, Sn or Pb plays an important role. Not only does the electronegativity of the elements gradually decrease from Ge to Pb making the N-M bond more polar, but also, the atomic radii increase making the N-M bond distance longer from Ge to Pb [14].

2,3-Dimethylbutadiene reacts with the germylene **1** partially to the germacyclopentene **4** while **2** and **3** give no comparable reactions with the diene (eqn 2 and [12]).

A less classical reaction is found when, in the place of the open chain diene, cyclopentadiene is allowed to react with **1**, **2** or **3**. In the case of **1**, no reaction occurs between the germylene and cyclopentadiene, while for **2** addition across the Sn-N bond is observed (Scheme 3). In the case of **3**, the addition product **6** can be detected by spectroscopy but it reacts with a further equivalent of cyclopentadiene to form dicyclopentadienyllead [15].

The structure of compound **5** has been determined by X-ray structure analysis, the result is depicted in Fig. 1. From this analysis, it is clear that the Sn-N(H) [2.468(7) Å] bond is elongated when compared

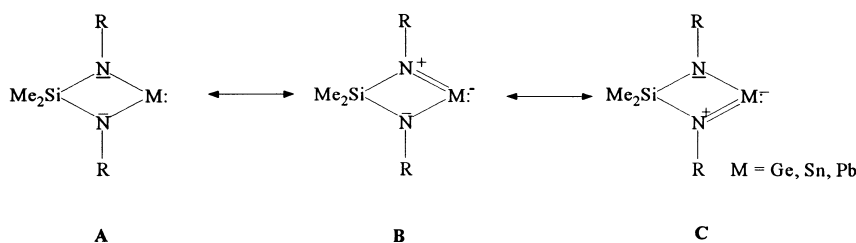

Scheme 1

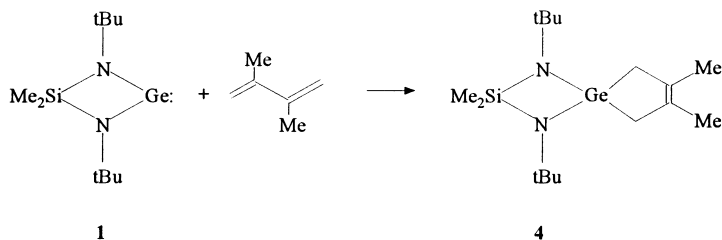

Scheme 2

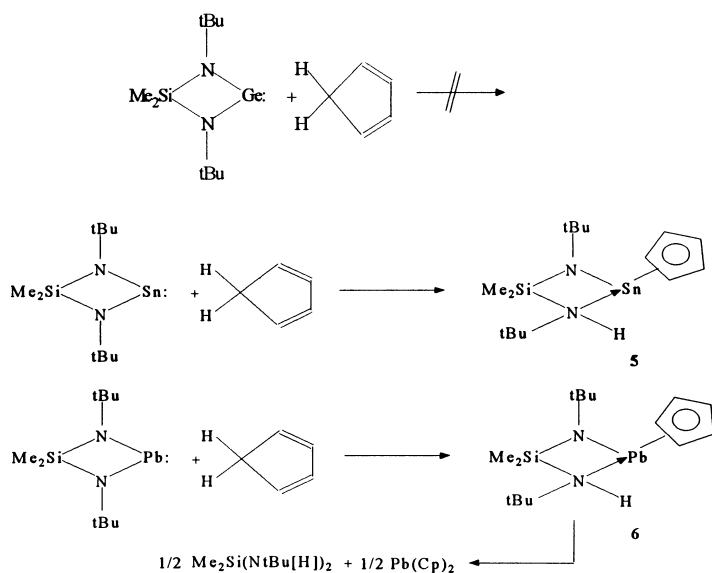

Scheme 3

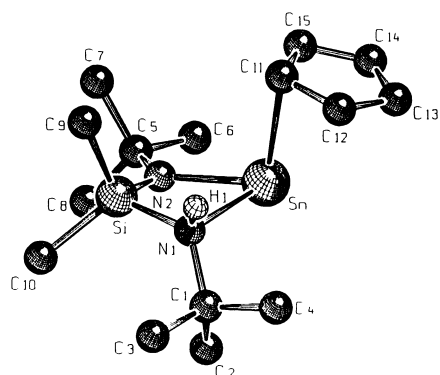
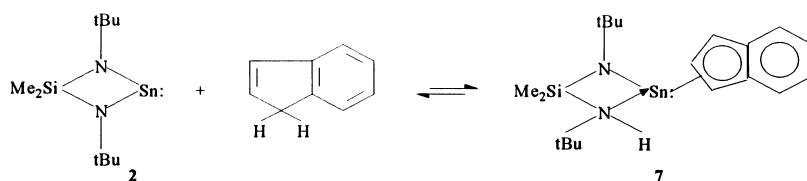

Fig. 1 X-ray structure of compound 5.

to the other Sn–N bond [2.117(7) Å] and the cyclopentadienyl ligand is almost parallel to the SnN_2 plane. The Sn–cyclopentadienyl distances are in the range of Sn π -bonded interactions.

It is remarkable to note that indene and stannylene **2** are in an equilibrium with the corresponding indenyl adduct **7** (Scheme 4, [15]).

At low temperatures the equilibrium can be shifted to the adduct **7** which from low temperature X-ray diffraction evidence reveals of a N–H \cdots C bridge to one of the α -carbon atoms of the five membered ring [15]. This special bonding feature not only explains the facile dissociation of **7** to indene and **2**, but also gives some insight into the interaction of bis(amino)stannylenes with π -systems which seems to start through bonding of the empty p-orbital at tin with one of the bonding π -orbitals of the organic compound.



Scheme 4

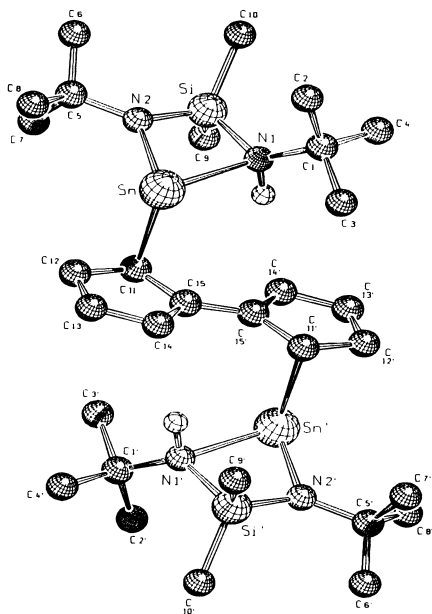

Fig. 2 X-ray structure of compound **8**.

The cyclopentadiene adduct **5** can also be obtained by treating the transition metal complex $\text{Ni}[\text{Sn}(\text{NtBu})_2\text{SiMe}_2]_4$ [16] with cyclopentadiene. In this reaction, compound **8** is obtained as a side product which contains two fused cyclopentadienyl groups each of these coordinated by $\text{Me}_2\text{Si}(\text{NtBu})(\text{NtBu}[\text{H}])\text{Sn}$ (see Fig. 2 and [17]).

If bis(cyclopentadienyl)nickel is allowed to react with the bis(amino)germylene (**1**) or the -stannylene (**2**) a double insertion of two carbene analogues into the nickel-cyclopentadiene bond is observed (Scheme 5, [18]). This again shows the philicity of the metal amides **1** and **2** towards organic π -systems.

After these insertions, the nickel atom has an 18-electron configuration. The structures can be described as trimetallic NiGe_2 or NiSn_2 clusters sandwiched between two cyclopentadienyl entities. The two structures **9** and **10** are different, the Ge-Ge-bridging cyclopentadienyl unit is unsymmetrical in **9** whereas the corresponding bridge in **10** is symmetrical. The whole $[\text{Me}_2\text{Si}(\text{NtBu})_2\text{M}]_2\text{Cp}^\ominus$ unit is electronically similar to the $[\text{Me}_2\text{Si}(\text{NtBu})_2\text{M}]_2\text{X}^\ominus$ bridge ($\text{X} = \text{halide}$) which is found in $\text{X}[\text{Me}_2\text{Si}(\text{NtBu})_2\text{M}]_2\text{M}'[\text{M}(\text{NtBu})_2\text{SiMe}_2]_2\text{X}$ ($\text{M}' = \text{Ni, Pd, Pt}$; $\text{M} = \text{Ge, Sn}$; $\text{X} = \text{Cl, Br}$) [19].

We have also allowed the carbene analogues **1** and **2** to react with another cyclic diene, cyclohexadiene (Scheme 6 and [20]).

Astonishingly, the reaction is somewhat different from those discussed before. While **1** does not react at all, the stannylene **2** reduces cyclohexadiene to benzene; at the same time, the amine $\text{Me}_2\text{Si}[\text{NtBu}(\text{H})]_2$ and elemental tin are formed. We were not able to detect an intermediate, which could have been the adduct of **2** and cyclohexadiene. This reaction is nevertheless remarkable as it provides a synthetic route to aromatic hydrocarbons; we have not evaluated this method in more detail.

The full structural proof of a donor acceptor complex between a bis(amino) carbene analogue and a

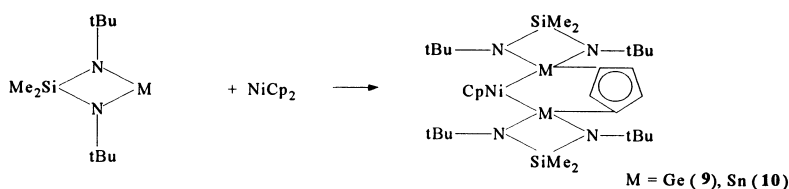

Scheme 5

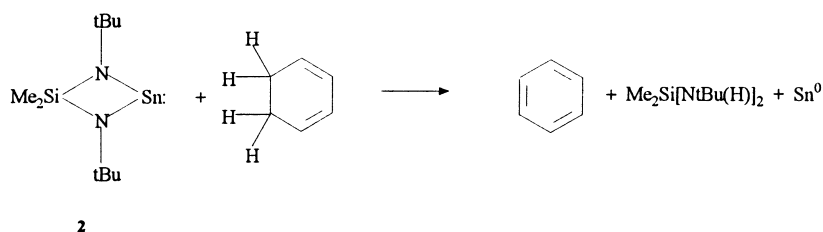

Scheme 6

simple organic π -system without a shift of a proton to one of the nitrogen atoms has been established from the X-ray structure analysis of the adduct between **2** and $\text{Ph}_3\text{P}=\text{CH}_2$ (Scheme 7 and [21]).

Complex **11a** has several remarkable features: (a) the Sn–C bond is almost perpendicular to the SnN_2 plane, (b) the Sn–C distance of 2.40(1) Å is much larger than an ordinary Sn–C single bond (2.20 Å). The well known high π electron density at the carbon atom of the starting ylid is reflected by the easy formation of this adduct **11a** (see general statements at the beginning of this chapter). Another remarkable property of **11a** is its equilibrium with an isomer **11b** as shown in Scheme 8.

The adduct **11b** can be isolated as orange crystals from the reaction mixture (**11a** forms yellow crystals) and differs from **11a** by an C–H \cdots N interaction from one of the phenyl groups on the phosphorus atom. The N \cdots H–C interaction is evident from the C \cdots N distance (3.45(1) Å) and from the tetrahedral geometry around the nitrogen atom to which the hydrogen atom is oriented in contrast to the second nitrogen atom in the molecule which is almost trigonal planar.

On heating a solution of **11b** the silylamine $\text{Me}_2\text{Si}(\text{NtBu}[\text{H}])_2$ is formed and a polycyclic compound **12**, the structure of which was deduced from spectroscopic methods and single crystal X-ray diffraction (see Scheme 9 and [21]) studies.

The formation of **12** may be explained by a 2 + 2 cycloaddition of a transient $-\text{Sn}=\text{C}(\text{H})-$ double bond. We have shown that when the two hydrogen atoms on the ylid-carbon are replaced by deuterium, only one of these deuterium atoms is transferred as the silylamine formed is exclusively $\text{Me}_2\text{Si}(\text{NtBu}[\text{H}])(\text{NtBu}[\text{D}])$ and the polycycle **12** still has one deuterium bonded to the $(\text{Sn}_2\text{P})\text{C}$ atoms.

To sum up, the bis(amino)carbene analogues **1**, **2** and **3** easily react with organic π -systems, the tin compound **2** shows the greatest versatility. The neighbouring nitrogen atoms often participate in the reactions as they function as proton attractors. This special property differentiates these carbene analogues from carbon substituted derivatives such as $[(\text{Me}_3\text{Si})_2\text{CH}]_2\text{M}$ (M = Ge, Sn, Pb) [22].

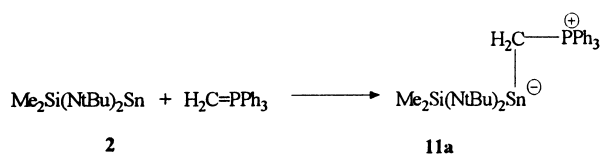

Scheme 7

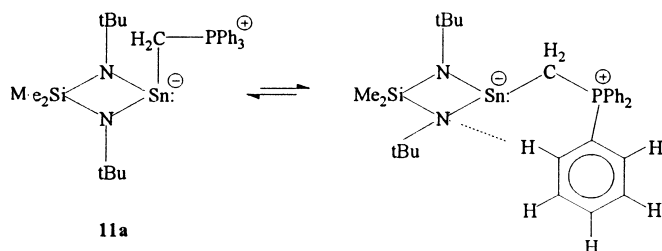

Scheme 8

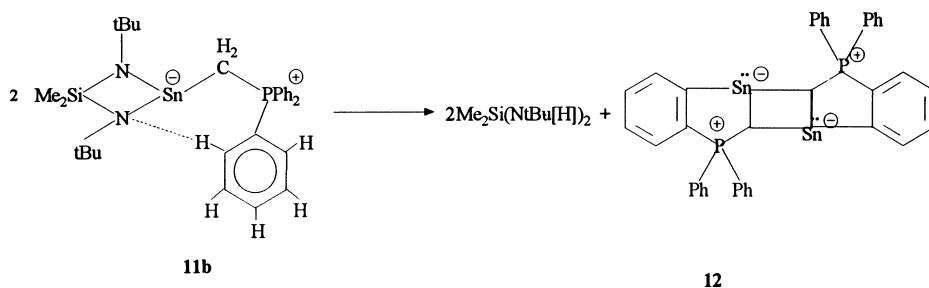

Scheme 9

BASE STABILIZED BIS(AMINO)GERMAIMINES AND -THIONES AND THE CORRESPONDING TRANSIENT STANNA DERIVATIVES

Germainines or germathiones are normally obtained with bulky substituents on the germanium atoms [23–26]. Our idea was to generate such thermodynamically unstable compounds by using a further intramolecular nucleophilic ligand to raise the coordination number at the germanium or tin atom. For this purpose we have synthesized a variety of silazanes (**13**, **14**, **15**, Scheme 10) which consist, apart from the N–H groups used for bonding to germanium or tin atoms, of basic atoms (nitrogen or oxygen) [27–29].

While **13** is a bis(amine), **14** and **15** are mono-amines. Before bonding to germanium or tin, the amines **13**–**15** must first be converted to the corresponding lithium derivatives. The lithium derivatives of **13** and **15** have been isolated and structurally characterized by X-ray diffraction [27,29].

The lithium amide derived from **15** is very remarkable as it crystallizes in two different solid phases. The monoclinic low temperature phase is made up of dimeric molecules, the lithium atoms being coordinated by two nitrogen and two oxygen atoms each. This monoclinic phase can be transformed to a tetragonal one around room temperature. In this phase, the two lithium atoms within the dimer are moving around the center of gravity of the molecule as shown in Fig. 3. The movement can be followed by variable temperature solid state NMR spectroscopy of several nuclei within the molecule (${}^6\text{Li}$, ${}^7\text{Li}$, ${}^{13}\text{C}$, ${}^{29}\text{Si}$). Lithium movement within a crystalline state on a discrete trajectory is a new finding in solid state chemistry.

From the lithium compounds, the corresponding germynes and stannynes are formed by reaction with GeCl_2 -dioxane or SnCl_2 in diethyl ether with precipitation of lithium chloride. In Scheme 11, the transformation to germainines and germathiones are depicted [30–32].

The X-ray diffraction analysis of the germainine **16** shows that the $\text{N}\rightarrow\text{Ge}$ donor bond is almost perpendicular to the planar $\text{N}_2\text{Ge}=\text{N}$ group and the $\text{N}\rightarrow\text{Ge}$ distance is, at $2.045(7)$ Å much longer than the

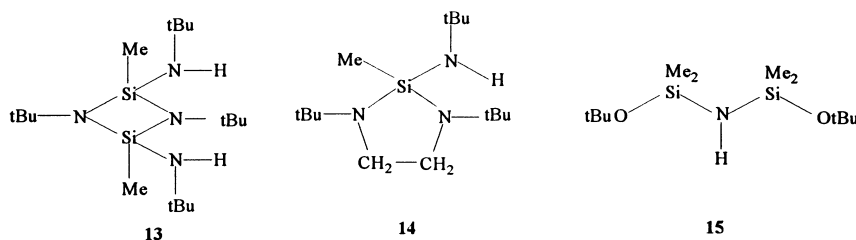

Scheme 10

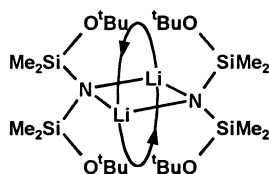
Fig. 3 Lithium movement in solid state in the dimer lithium compound of **15**.

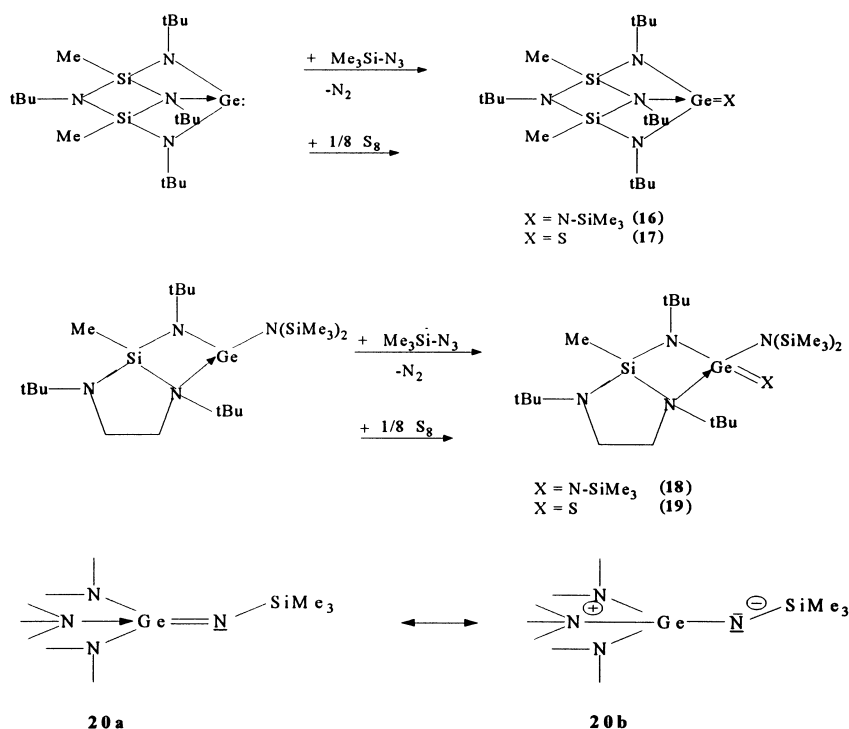

Scheme 11

other Ge–N bonds. The Ge=N bond is the shortest at 1.688(9) Å. From these data, it becomes evident that the base-stabilized germainimines and -thiones are not equivalent to the well-known phosphorylides, but are quite similar as can be seen from the mesomeric forms **20a** and **20b**.

Figure 4 represents the X-ray diffraction analysis result for compound **17**. Again, the equiplanar arrangement of the N₂Ge=S group should be noted.

Temperature dependent NMR spectra (¹H and ¹³C) of **16–19** show high mobility in the compounds especially between the two donor nitrogen atoms which are in competition for the electrophilic germanium atom. Another special effect is found in compound **18**: at higher temperatures the trimethylsilyl groups are exchanging between the two nitrogen atoms (see also [32]) of the imino- and the bis(trimethylsilyl)amino group as shown in Scheme 12.

We have also exploited the reactivity of these double bonds, especially addition reactions. In Scheme 13, the syntheses of isomers **21** and **22** are depicted starting from **16** and adding either Li–CH₃ or I–CH₃ to the Ge=N double bond [33].

The addition of methyl iodide to the Ge=S bond of **17** is also possible, the methyl group being bonded

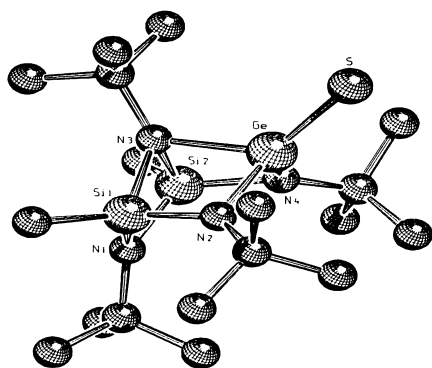
Fig. 4 X-ray structure of **17**.

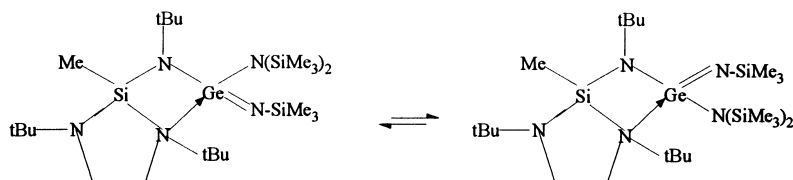

Scheme 12

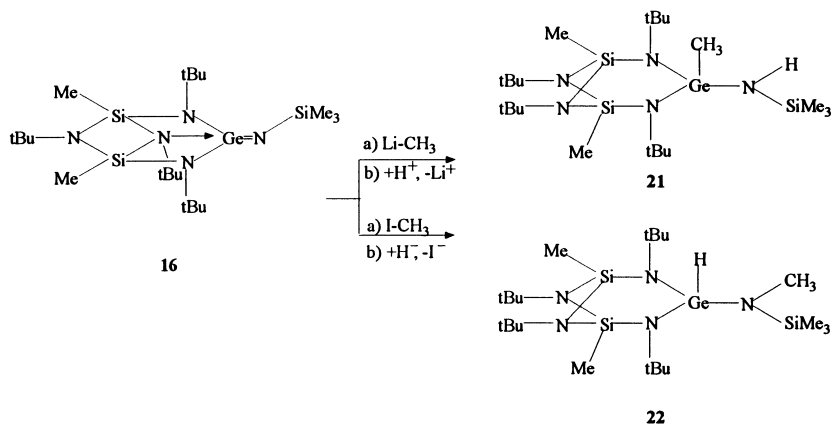

Scheme 13

to sulfur [34]. A quite spectacular addition is found when PCl_3 is added to **16**. The product of this addition is shown in Fig. 5, the PCl_2 group becomes attached to nitrogen while the chlorine is bonded to germanium. As in all other additions the former $\text{N} \rightarrow \text{Ge}$ donor bond is no longer present, the germanium atom being almost ideally tetrahedrally coordinated [35].

It is interesting to note that the organic substituents on the nitrogen atoms acting as intramolecular bases are important for the stability of compounds **16**–**19**. When the tert-butyl groups in **18** are replaced by trimethylsilyl groups, the corresponding germaine **23a** is not stable but rearranges through trimethylsilyl migration to the isomer **23b**, which no longer contains a $\text{Ge}=\text{N}$ multiple bond (Scheme 14, [32]).

We have tried to extend this intramolecular base stabilization concept to the synthesis of tin imines or thiols without great success. The tin(II) compound **24** corresponding to the bis(amino)germylene of Scheme 11 reacts with phenyl azide not in a 1:1 stoichiometry but in a 1:2 ratio leading to a cyclic stannatetrazole **25** (eqn 15, [36]).

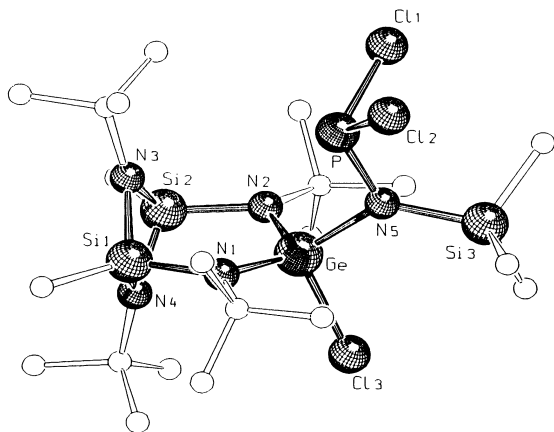
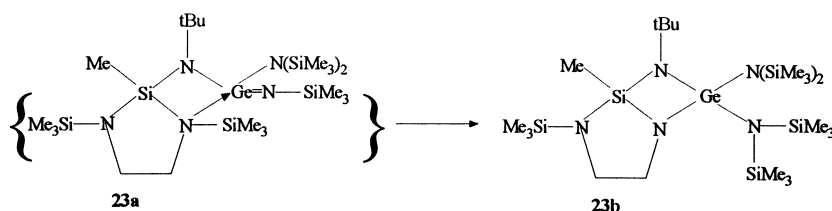
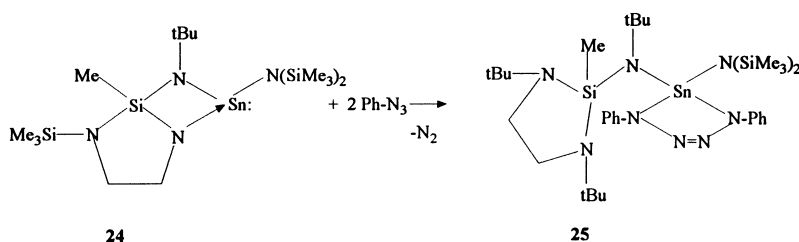

Fig. 5 X-ray structure of $[\text{MeSi}(\text{NtBu})_2]_2\text{Ge}(\text{Cl})[\text{N}(\text{PCl}_2)(\text{SiMe}_3)]$.



Scheme 14



Scheme 15

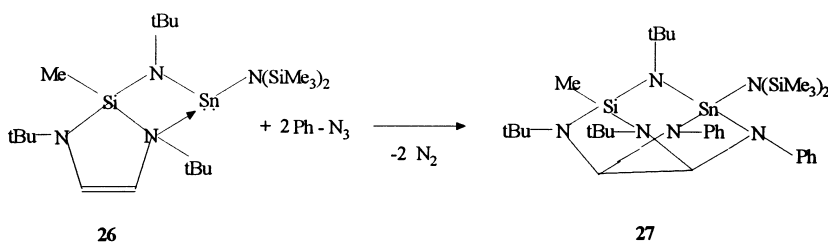

Scheme 16

This reaction is typical for stannylenes even with bulky substituents [37,38]. The formation of **25** can be easily explained by the formation of a transient stannamine which undergoes a 1,3-dipolar cycloaddition with more phenyl azide. Other amino ligands on tin(II), like those derived from **13** and **15** (see above), do not prevent the formation of the corresponding stannatetrazoles [36].

We thought it would be exciting to use the high reactivity of the transient stannamine in combination with another π -system such as an activated C=C double bond, which normally reacts with azides to give a three-membered NC₂-cycle (aziridine). We therefore changed the saturated compound **24** into the 'unsaturated' compound **26**, which now had, principally two unsaturated centers, and repeated the reaction with phenyl azide (Scheme 16, [39]).

In contrary to eqn 15, two equivalents of dinitrogen were evolved during the reaction. Neither the C=C double bond nor the tin(II) center survived the reaction conditions: two nitrenes were added across the π -bond and the tin connects the two centers to form a C₂N₂Sn ring. As a result of this reaction, the polycyclic cage **27** is formed which combines silicon and tin mostly bonded to nitrogen while the organic part of the compound is a tetraaminoethane. The reaction is quantitative and **27** has been characterized by spectroscopic and X-ray diffraction methods. From a mechanistic point of view, **27** could have been formed by a reaction between a transient stannamine and an aziridine or by the reaction between an ene-diamine and a stanna tetrazole with elimination of nitrogen. None of these possible intermediates have been detected spectroscopically.

SINGLE SOURCE PRECURSOR APPROACH TO METAL/METAL OXIDE COMPOSITES USING LOW VALENT METAL ALKOXIDES OR METAL ALKOXYHYDRIDES

The development of new materials for special applications in physics and engineering is mostly driven by skilled physicists and engineers who use techniques such as ion implantation, ultra high vacuum

processes, ball milling, metal annealing, solid state chemistry, etc. Although chemical routes to new materials, especially in the field of coatings, like MO-CVD (Metal Organic Chemical Vapour Deposition) or sol-gel techniques have been known for a long time, they are normally performed with very simple molecular compounds [40]. The usual way to prepare a coating of BaTiO₃, for example, is to start with ionic or molecular precursors containing barium or titanium and mixing the two components in a water/alcohol mixture to get a gel which on heat treatment is transformed to the oxide. There are two major problems in this procedure: (a) the rate of hydrolysis of the metal components may be rather different, which will lead to clustering of one metal oxide (for example (TiO₂)_x) at the expense of the other metal component; (b) the impurities in the product, which may arise from the counteranions or from the solvents or stabilizers employed, might be difficult to expel and therefore very high temperatures are needed to get the desired product.

In addition to these difficulties outlined for some simple oxides, other problems are added if a composite of two phases has to be made and processed. A composite of a metal implanted in a metal oxide, a material which could be useful for electronics and ceramic/metal engineering, is not trivial to make, although ball milling or ion implantation could be employed as techniques for this purpose. The most difficult task is to obtain a homogeneous dispersion of one phase into the other.

A synthetic chemist could make a valuable contribution by synthesizing a compound which on heating or radiation, decomposes to give a metal and an oxide on a molecular level after liberating volatile gaseous side products which could be pumped off at reduced pressure. As the metal and the metal oxide are produced on a molecular level, their homogeneous distribution should be favoured before reaching the temperature at which phase separation becomes important. By choosing adequate ligands on the metallic elements, such a process which works with one single precursor molecule, should be, in principle, possible.

Our first experience in this field came by accident. When we decomposed the volatile bimetallic alkoxide Sn(OtBu)₃Ba(OtBu)₃Sn on a heated metallic substrate (350 °C), we noticed that a mixture of oxides like BaO and SnO was not obtained, but instead, two distinct phases of BaSnO₃ and β-Sn were obtained in a reproducible way [41]. Analysis of the volatile products by mass spectrometry (which was directly coupled to the CVD process) revealed that the overall decomposition process is very simple as illustrated in Scheme 17.

The main gaseous products were isobutene and tert-butanol in an almost 1:1 ratio. Using electron microscopy (SEM and TEM), Auger- and ESCA-spectroscopy and X-ray powder diffraction, it was established that the solid biphasic material was made up of spherical metal particles which were encased in an amorphous oxide matrix and clustered to form ball shape entities. These entities were parts of even bigger balls. In Fig. 6, a scanning electron micrograph of a section of such a fractal growth is given. Depending on the processing conditions, the composite balls ranged in size from 50 nm to several

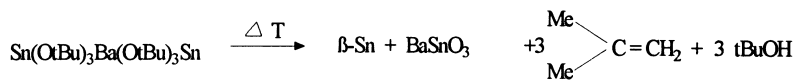

Scheme 17

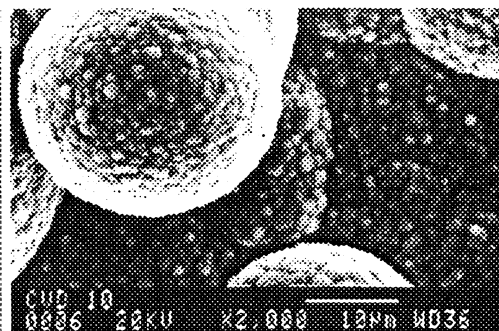
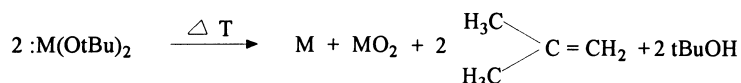

Fig. 6 Electron microscope picture of Sn·BaSnO₃.



Scheme 18

microns. Another characteristic property of these composites was the very strict 1:1 stoichiometry of Sn(0) to Sn(IV) and the low carbon content, which was found to be below 1%.

Our conclusions from this experiment were, that: (a) under the CVD conditions tin(II) is not stable and disproportionates into tin(0) and tin(IV), and (b) tert-butoxy groups are very well suited for such a thermal process (they promote the volatility of the molecules and give simple gaseous side products). We showed in subsequent experiments [42] that the same sort of CVD process could also be applied to the germanium and lead compounds $\text{Ge}(\text{OtBu})_3\text{Ba}(\text{OtBu})_3\text{Ge}$ and $\text{Pb}(\text{OtBu})_3\text{Ba}(\text{OtBu})_3\text{Pb}$ (and derivatives with Ca or Sr in place of Ba) always leading to similar composites. These were of either the formulae $\text{Ge}\cdot\text{MGeO}_3$ ($M = \text{Ca}, \text{Sr}, \text{Ba}$) or $\text{Pb}\cdot\text{MPbO}_3$ ($M = \text{Ca}, \text{Sr}, \text{Ba}$) [42].

Furthermore the tert-butoxides of divalent germanium, tin and lead gave the mixed valence, mixed phase composites of the type $M\cdot\text{MO}_2$ ($M = \text{Ge}, \text{Sn}, \text{Pb}$) (Scheme 18, [42]).

The above findings suggest that a single source precursor CVD to a metal/metal oxide composite had to proceed via an **intermediate oxidation state** of the metal which on disproportionation gives the elemental and the highly oxidized form of the same metal. While this is easily accessible for low valent group 14 elements since the +II oxidation state is reasonably stable, this might be much more difficult with other elements, especially aluminium. Aluminium(I) compounds are normally only transient or are only stable under rather unique conditions (see $[\text{CH}_3\text{Al}]_4$, $[\text{Cp}^*\text{Al}]_4$ or $(\text{ClAl})_4$, [43–45]) and are therefore **unsuitable** for CVD processes.

The challenge for us was to synthesize a molecule containing aluminium which simultaneously possesses both oxidizing and reducing ligands. We chose tert-butoxide and hydride as substituents on the aluminium atom. When we did the X-ray diffraction studies on single crystals of the molecules $[(\text{tBuOAlH}_2)]_2$ and $[(\text{tBuO})_2\text{AlH}]_2$ we realized that H. Nöth and coworkers had prepared one of these compounds several years before [46]. From our structural studies we could conclude that the dimers have a Al_2O_2 four-membered cycle in common [47]. We also prepared the deuterated compound $[(\text{tBuOAlD}_2)]_2$.

If the tert-butoxyalane is heated to more than 450°C , a composite is obtained which is made up of aluminium particles dispersed in an Al_2O_3 matrix [48]. The overall reaction is summarized in Scheme 19.

Dihydrogen and isobutene (no tert-butanol!) are found as the only volatile fragments by mass spectrometry. Using the deuterated sample, we have found that HD is exclusively formed with isobutene at lower temperatures whereas, beyond 350°C , also D_2 is detected. From this and other evidence, we conclude that the thermolysis process has to be separated into two steps as summarized in Scheme 20.

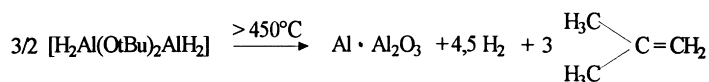

Scheme 19

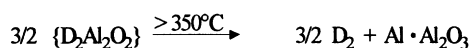
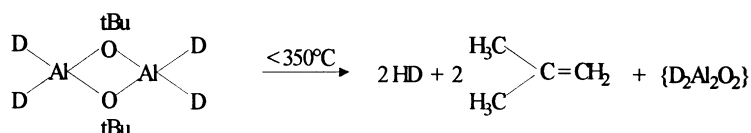

Scheme 20

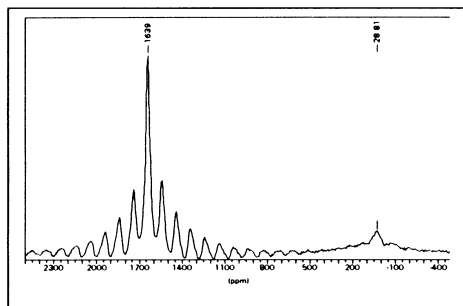

Fig. 7 52.1 MHz ^{27}Al SPE/MAS-spectrum at a spinning rate of 5 KHz of Al-Al $_2\text{O}_3$.

The driving force for the formation of the composite may be the instability of an 'Al $_2\text{O}_2$ ' intermediate which should result after the elimination of dihydrogen. In fact, the composite Al-Al $_2\text{O}_3$ is the disproportionation product of 'Al $_2\text{O}_2$ '. We are currently attempting to prove this hypothesis by further experiments.

The Al-Al $_2\text{O}_3$ composite can be produced with very small aluminium particles (approaching 1 nm) when the thermolysis process is run at moderate temperatures with strict control of the pressure. The small angle neutron diffraction study reveals again a fractal structure (compare above) with a fractal exponent of 2.4 [49]. In Fig. 7, the ^{27}Al MAS NMR of the solid composite is shown revealing the two aluminium oxidation states unequivocally.

To sum up this chapter, we have shown that special single source precursors used in CVD experiments may directly lead to biphasic metal/metal oxide composites of high purity and without any major contamination from undesired products. The concept, developed by us, makes major use of the instability of intermediate oxidation states of the metals. The formation of the composite is thus driven by chemistry and explains the good dispersion of the two phases.

CONCLUSIONS AND ACKNOWLEDGEMENTS

Metal centered molecules still represent an exciting area of research. The results represented in this article are a quite personal choice reflecting the versatility of these molecules. These results would not have been possible without financial support of different public and private organizations like Fonds der Chemischen Industrie, Deutsche Forschungsgemeinschaft, University of the Saarland, Hoechst AG, Frankfurt and BASF, Ludwigshafen. Some of this work has been supported by the DFG within the SFB 277, 'Grenzflächenbestimmte Materialien'. We thank Dr S. Mathur for reading the manuscript.

REFERENCES

- 1 D. C. Bradley. *Adv. Inorg. Chem. Radiochem.* **15**, 259 (1972).
- 2 R. C. Mehrotra. *Adv. Inorg. Chem. Radiochem.* **26**, 269 (1983).
- 3 D. C. Bradley, R. C. Mehrotra, D. P. Gaur. *Metal Alkoxides*. Academic Press, London (1978).
- 4 M. F. Lappert, P. P. Power, A. R. Sanger, R. C. Srivastava. *Metal and Metalloid Amides*. Ellis Horwood, New-York-Chichester, Brisbane-Toronto (1980).
- 5 P. J. Davidson, D. H. Harris, M. F. Lappert. *J. Chem. Soc., Dalton Trans.* 2268 (1976).
- 6 K. Gregory, P. von Ragué-Schleyer, R. Snaith. *Adv. Inorg. Chem.* **37**, 47 (1991).
- 7 E. R. Mulvey. *Chem. Soc. Rev.* **20**, 167 (1991).
- 8 M. Veith. *Chem. Rev.* **90**, 3 (1990).
- 9 M. Veith. *Phosphorus, Sulfur Silicon* **41**, 195 (1989).
- 10 A. H. Cowley, C. J. Carrano, R. L. Geerts, R. A. Jones, Ch. M. Nunn. *Angew. Chem.* **100**, 306 (1988).
- 11 M. Veith. *Angew. Chem.* **99**, 1 (1987); *Angew. Chem. Int. Ed. Engl.* **26**, 1 (1987).
- 12 M. Veith, M. Grosser. *Z. Naturforsch.* **37**, 1375 (1982).
- 13 M. Veith. *Angew. Chem.* **87**, 287 (1975); *Angew. Chem. Int. Ed. Engl.* **14**, 263 (1975).

- 14 M. Veith. *Z. Naturforsch.* **33b**, 7 (1978).
- 15 M. Veith, M. Olbrich, W. Shihua, V. Huch. *J. Chem. Soc. Dalton Trans.* 161 (1996).
- 16 M. Veith, L. Stahl, V. Huch. *J. Chem. Soc., Chem. Commun.* 359 (1990).
- 17 M. Veith, M. Olbrich. unpublished results.
- 18 M. Veith, L. Stahl. *Angew. Chem.* **105**, 123 (1993); *Angew. Chem. Int. Ed. Engl.* **32**, 106 (1993).
- 19 M. Veith, A. Müller, L. Stahl, M. Nötzel, M. Jarczyk, V. Huch. *Inorg. Chem.* **35**, 3848 (1996).
- 20 M. Veith, F. Töllner. *J. Organomet. Chem.* **246**, 219 (1983).
- 21 M. Veith, V. Huch. *J. Organomet. Chem.* **308**, 263 (1986).
- 22 J. D. Cotton, P. J. Davidson, M. F. Lappert. *J. Chem. Soc., Dalton Trans.* 2275 (1976).
- 23 A. Meller, G. Ossig, W. Maringgele, D. Stalke, R. Herbst-Irmer, St. Freitag, G. M. Sheldrick. *J. Chem. Soc., Chem. Commun.* 1123 (1991).
- 24 W. Ando, T. Ohtali, Y. Kabe, *Organometallics* **13**, 434 (1994).
- 25 M. Saito, N. Tokitoh, R. Okazaki. *Chem. Lett.* **4**, 265 (1996).
- 26 M. C. Kuchta, G. Parkin, *J. Chem. Soc., Chem. Commun.* 1351 (1994).
- 27 M. Veith, G. Goffing, V. Huch. *Chem. Ber.* **121**, 943 (1988).
- 28 M. Veith, A. Rammo. *Z. anorg. allg. Chem.* **623**, 861 (1997).
- 29 M. Veith, M. Zimmer, K. Fries, J. Böhnlein-Maus, V. Huch. *Angew. Chem.* **108**, 1647 (1996); *Angew. Chem. Int. Ed. Engl.* **35**, 1529 (1996).
- 30 M. Veith, S. Becker, V. Huch. *Angew. Chem.* **102**, 186 (1990); *Angew. Chem. Int. Ed. Engl.* **29**, 216 (1990).
- 31 M. Veith, S. Becker, V. Huch. *Angew. Chem.* **101**, 1287 (1989); *Angew. Chem. Int. Ed. Engl.* **28**, 1237 (1989).
- 32 M. Veith, A. Rammo, M. Hans. *Phosphorus, Sulfur Silicon* **93–94**, 197 (1994).
- 33 M. Veith, A. Detemple, V. Huch. *Chem. Ber.* **124**, 1135 (1991).
- 34 M. Veith, A. Detemple. *Phosphorus, Sulfur Silicon* **65**, 17 (1992).
- 35 M. Veith, A. Detemple, unpublished results.
- 36 M. Veith, B. Schillo, unpublished results.
- 37 K. Alder, F. H. Flock, A. Hausweiler, R. Roeber. *Chem. Ber.* **87**, 1752 (1954).
- 38 H. Grützmacher, H. Pitzkow. *Angew. Chem.* **103**, 976 (1991); *Angew. Chem. Int. Ed. Engl.* **30**, 216 (1991).
- 39 M. Veith, B. Schillo, V. Huch. *Angew. Chem.* 110 (1998), in press.
- 40 H. O. Pierson. *Handbook of Chemical Vapour Deposition*. Noyes Publications, Park Ridge, USA (1992).
- 41 M. Veith, S. Kneip. *J. Mater. Sci. Lett.* **13**, 335 (1994).
- 42 M. Veith, S. Kneip, A. Jungmann, S. Hüfner. *Z. anorg. allg. Chem.* **623**, 1507 (1997).
- 43 C. h. Schnitter, H. W. Roesky, C. Röpken, R. Herbst-Irmer, H.-G. Schmidt, M. Noltemeyer. *Angew. Chem. Int. Ed. Engl.* **37**, 1952 (1998)
- 44 (a) C. Dohmeier, C. Robl, M. Tacke, H. Schnöckel. *Angew. Chem.* **103**, 594 (1991); *Angew. Chem. Int. Ed. Engl.* **30**, 564 (1991). (b) S. Schulz, H. W. Roesky, H. J. Koch, G. M. Sheldrick, D. Stalke, A. Kuhn. *Angew. Chem.* **105**, 1828 (1993).
- 45 C. Dohmeier, D. Loos, H. G. Schnöckel. *Angew. Chem.* **108**, 141 (1996); *Angew. Chem. Int. Ed. Engl.* **35**, 129 (1996).
- 46 H. Nöth, H. Suchy. *Z. anorg. allg. Chem.* **358**, 44 (1968).
- 47 M. Veith, S. Faber, H. Wolfanger, V. Huch. *Chem. Ber.* **129**, 381 (1996).
- 48 M. Veith, S. Kneip, S. Faber, E. Fritscher. *Materials Science Forum* **269–272**, 303 (1998).
- 49 M. Veith, S. Faber, R. Hempelmann, S. Janßen, J. Prewo, H. Eckerlebe. *J. Mat. Sci.* **311**, 2009 (1996).